

larghezza luce = 1200/1400/1600

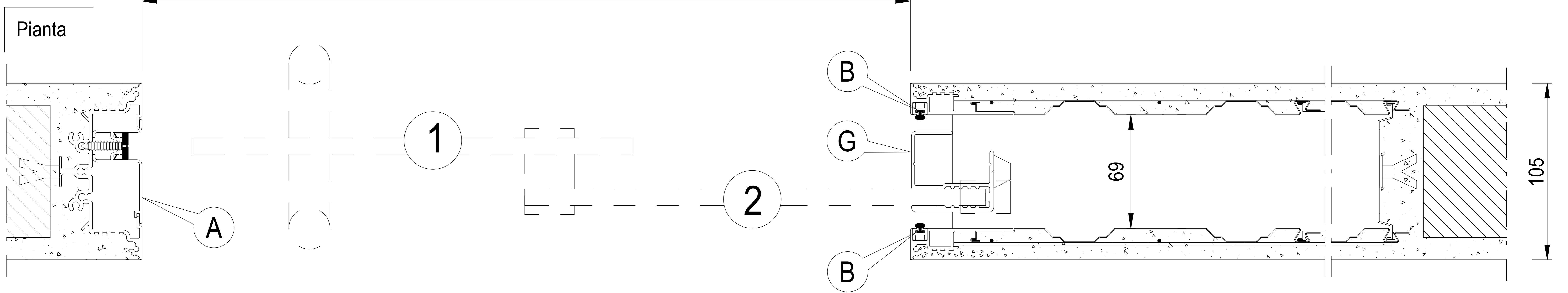

**MONTAGGIO  
PROFILO "A"**

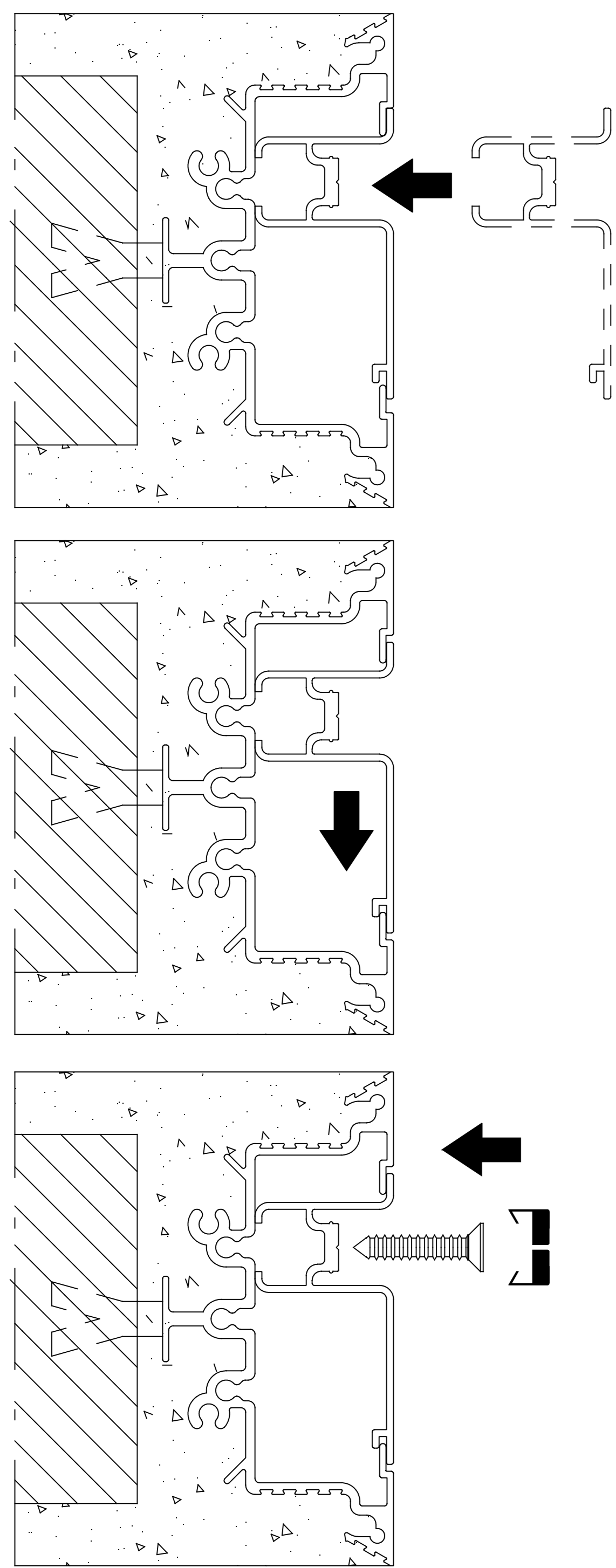

**PROFILO "A"**

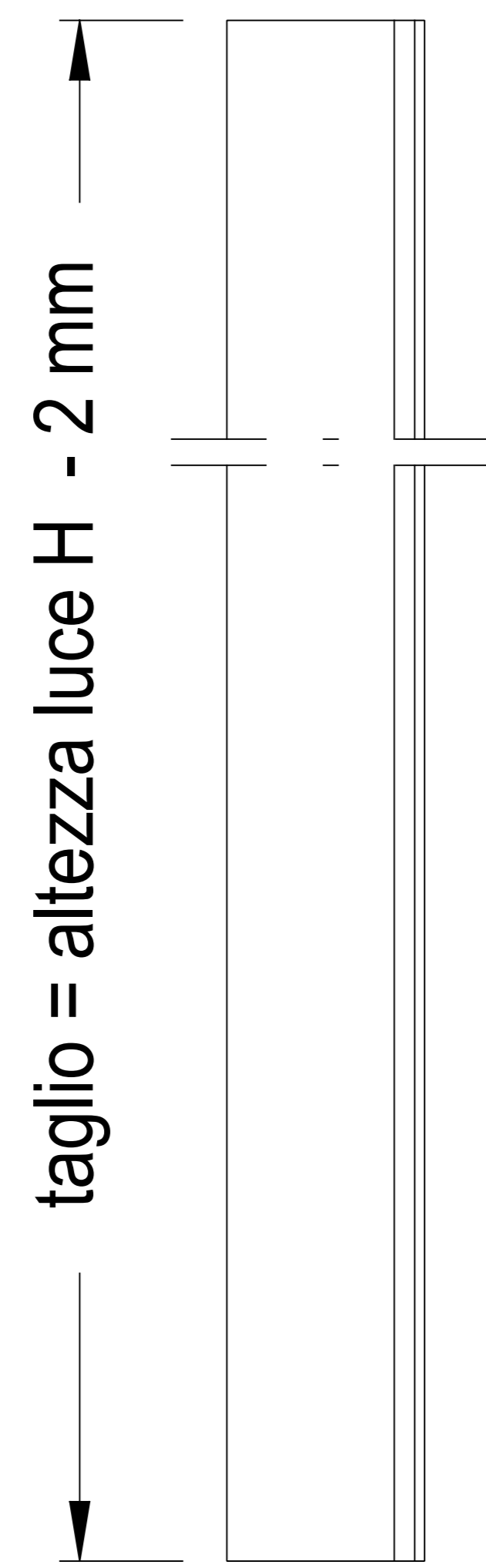

**PROFILI "B"**

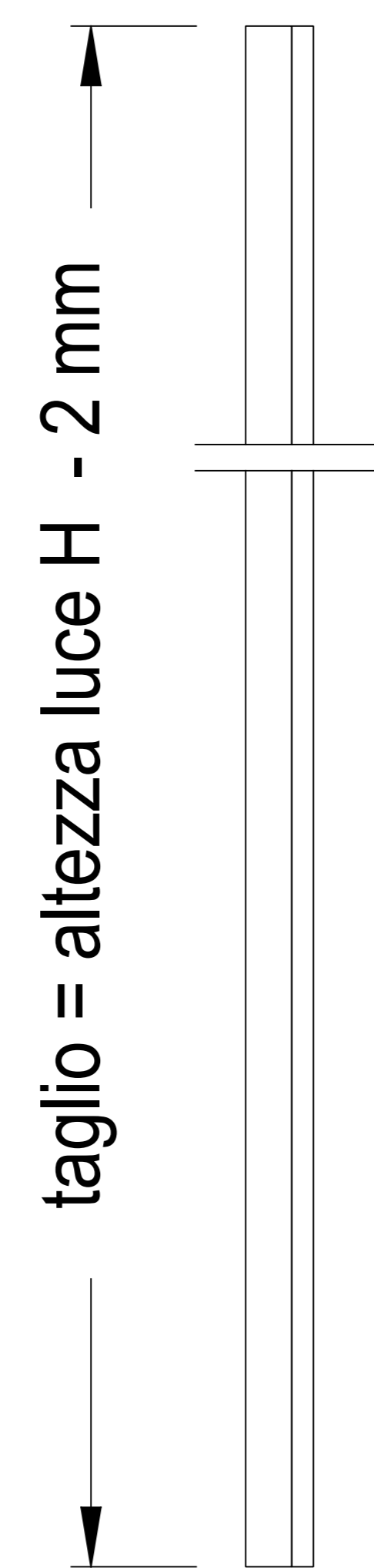

**TAGLIO PROFILI**

**PROFILO "G"**

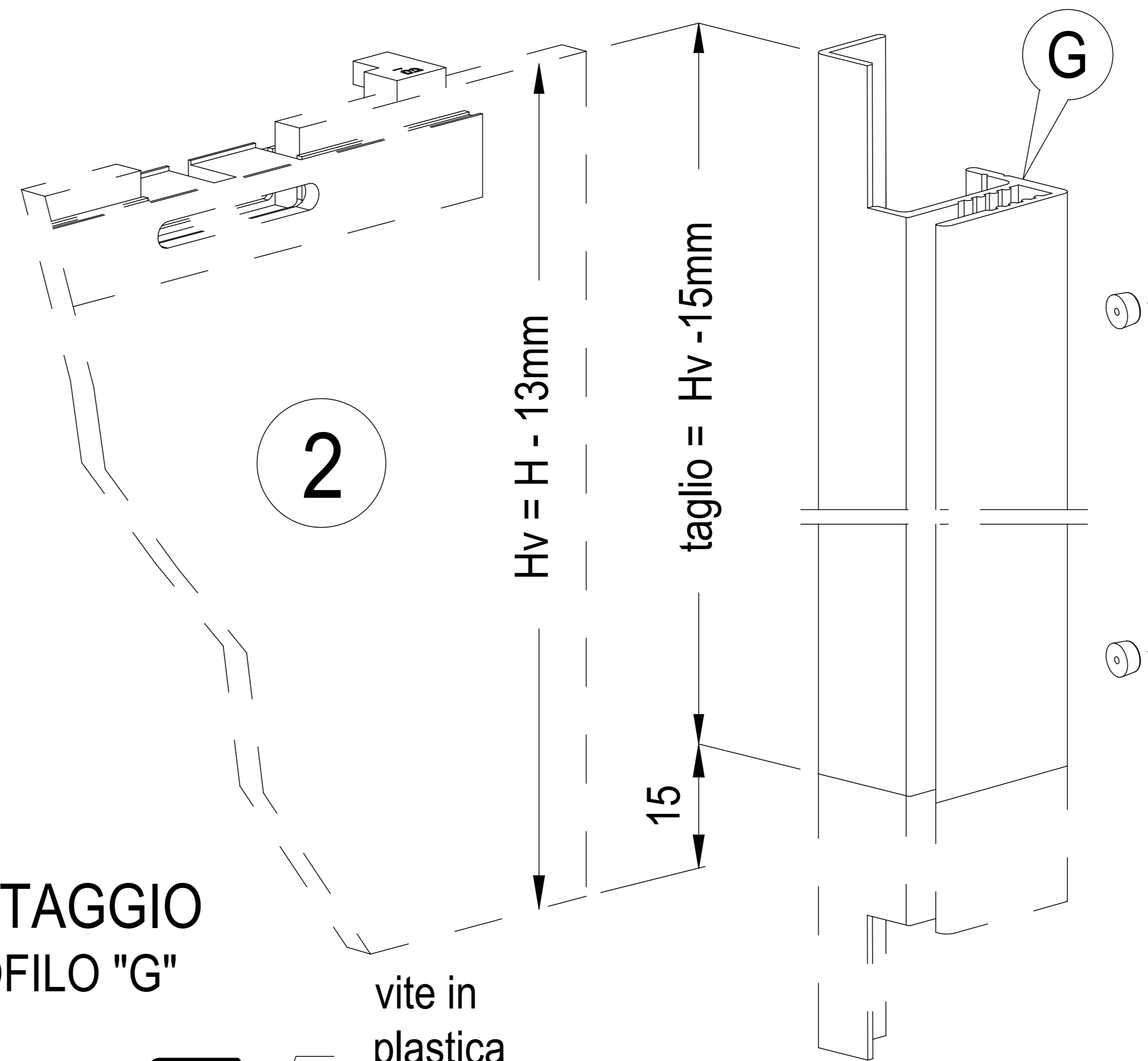

**MONTAGGIO  
PROFILO "G"**

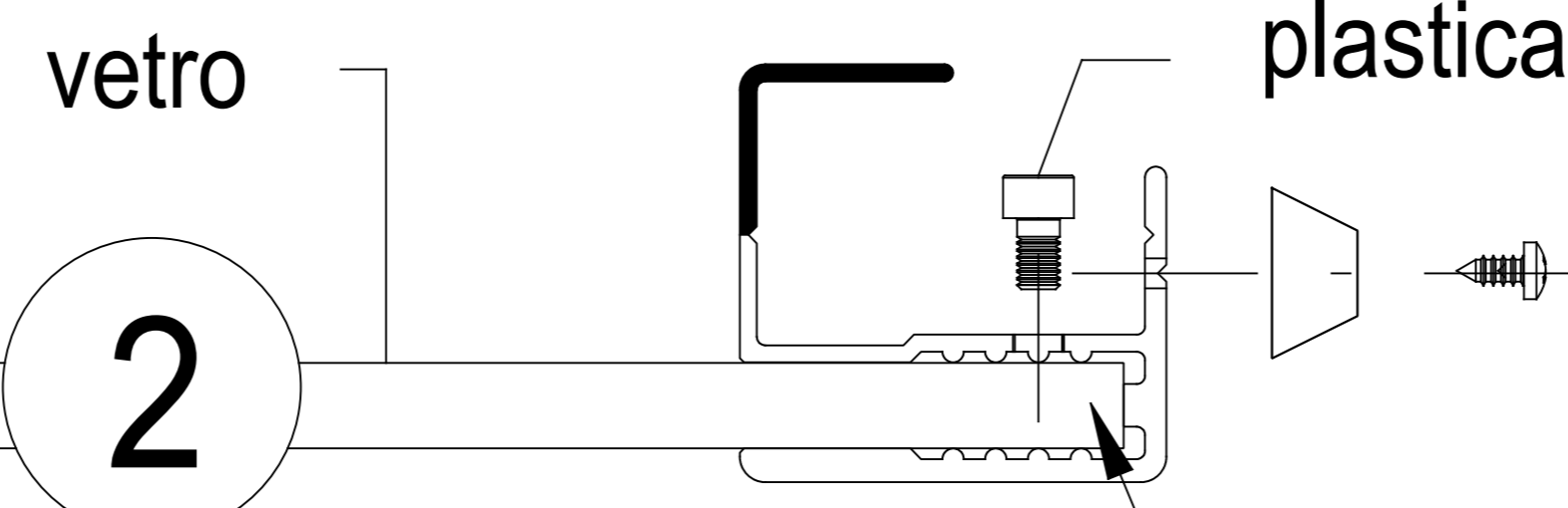

incollare a tratti con silicone neutro  
e fissare con le viti in plastica

**Sezione**

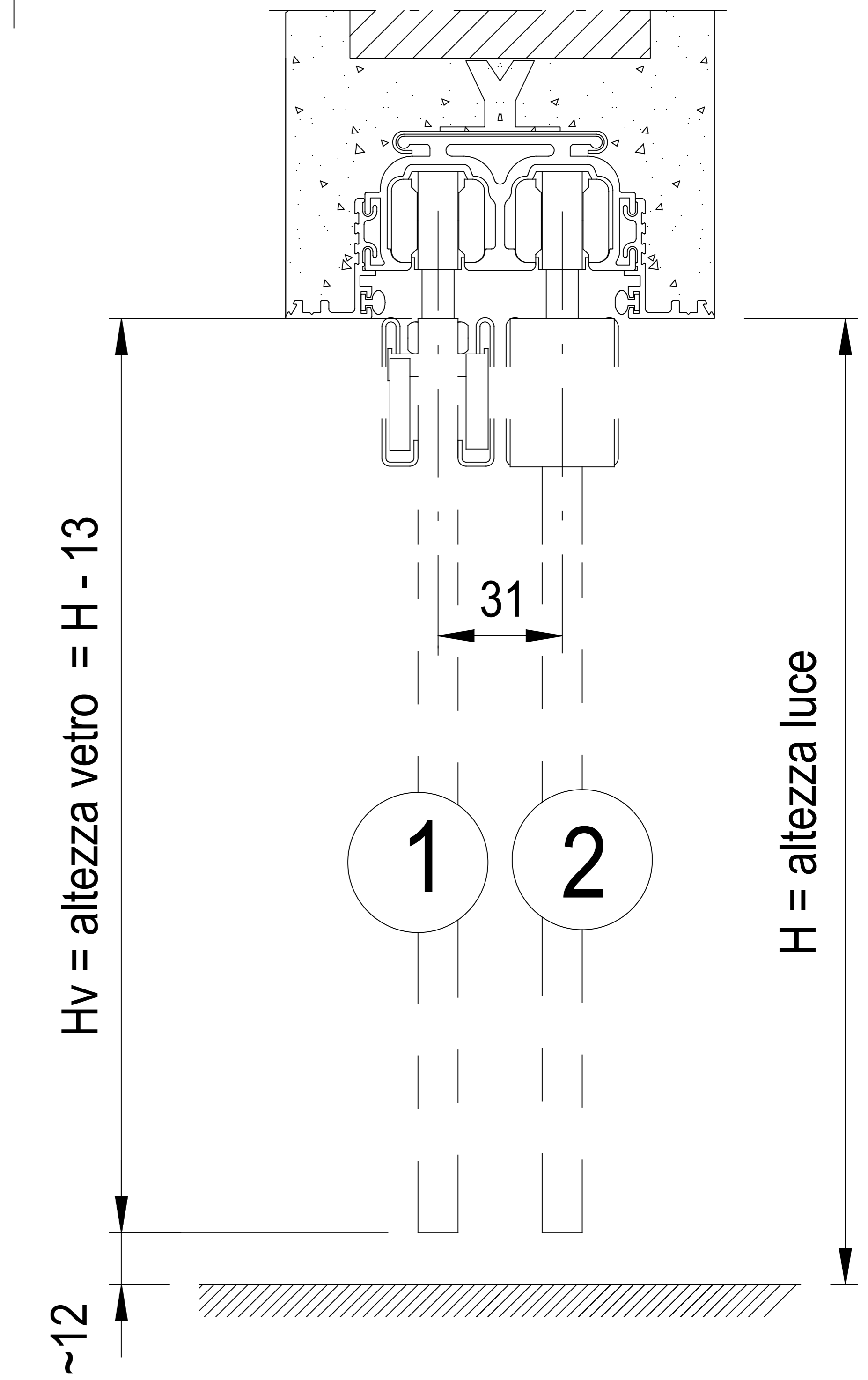

altezza luce	altezza vetro	taglio profilo (G)
H	Hv = H - 13	Hv - 15
2000 / 2100	1987 / 2087	1972 / 2072
2110 ÷ 2400	2097 ÷ 2387	2082 ÷ 2372

# KIT COMPONENTI ESSENTIAL DUAL

preparazione per anta con verso sinistro

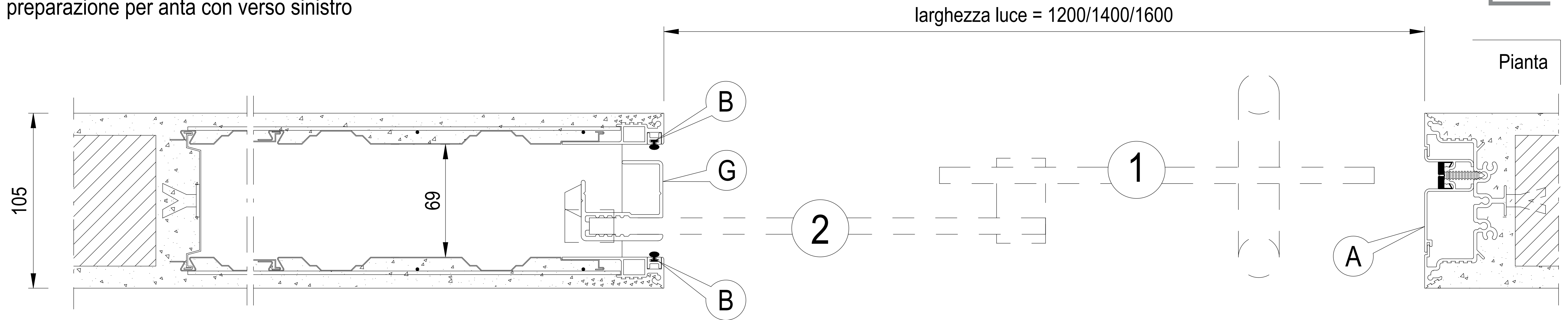

## MONTAGGIO PROFILO "A"

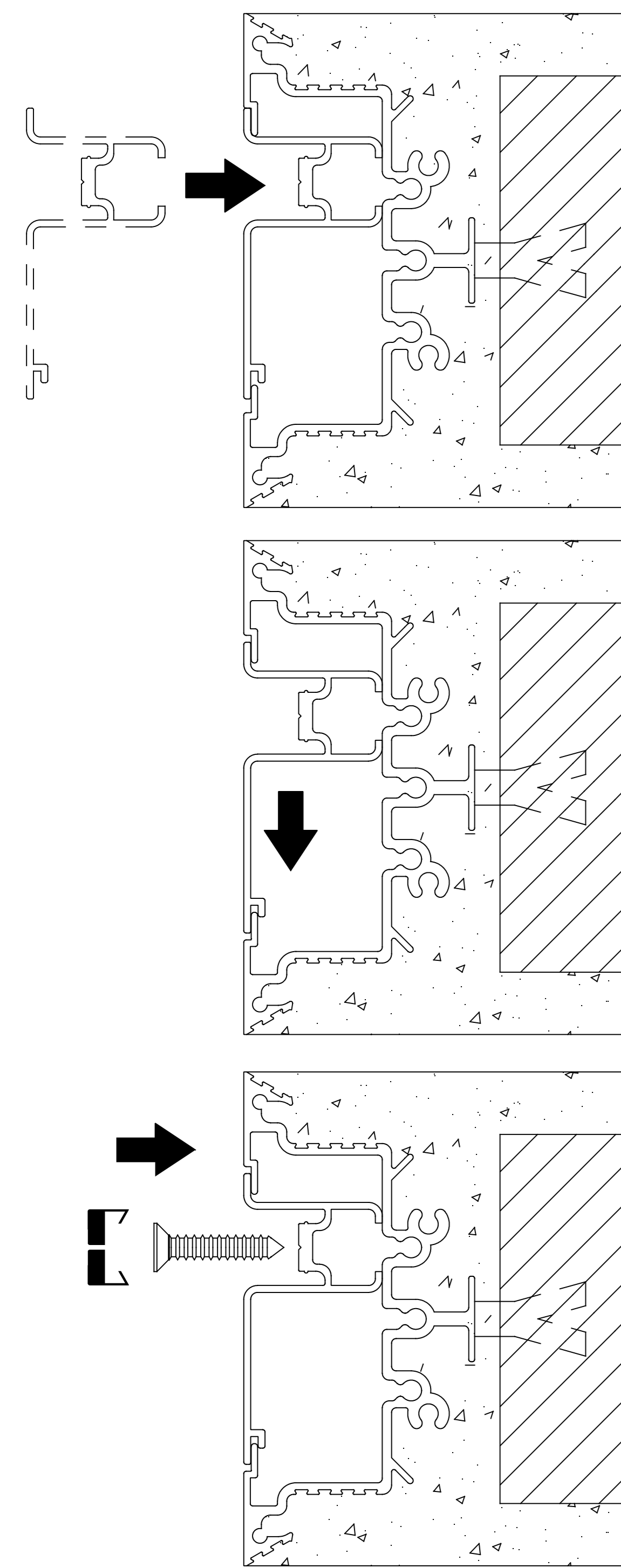

## TAGLIO PROFILI

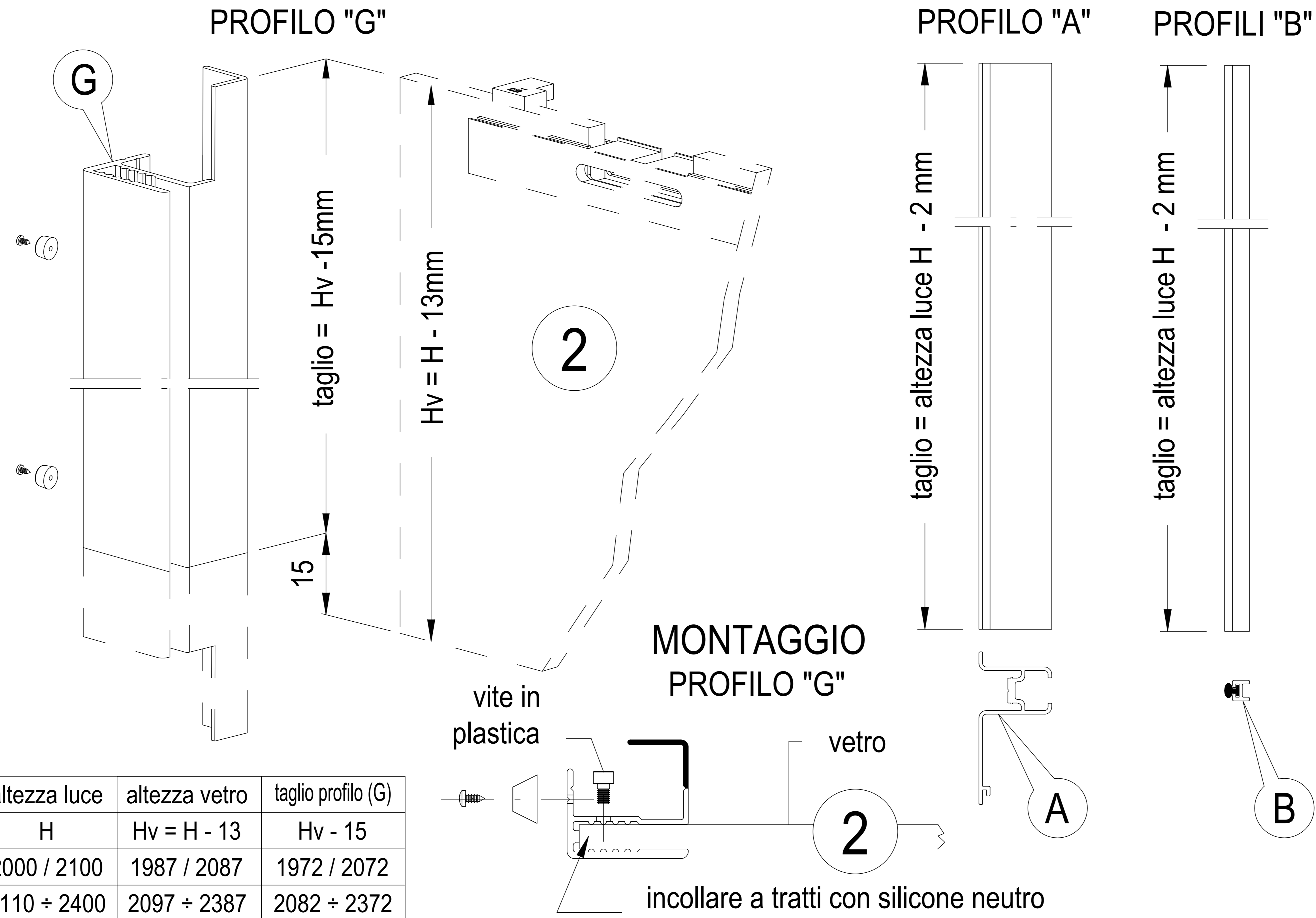

altezza luce	altezza vetro	taglio profilo (G)
H	$H_v = H - 13$	$H_v - 15$
2000 / 2100	1987 / 2087	1972 / 2072
2110 ÷ 2400	2097 ÷ 2387	2082 ÷ 2372

## Sezione

