

ANTE E STIPITI-KŘÍDLA A ZÁRUBNĚ-KŘÍDLA A ZÁRUBNĚ-TÜREN UND TÜRPFOSTEN-DOORS AND END POSTS

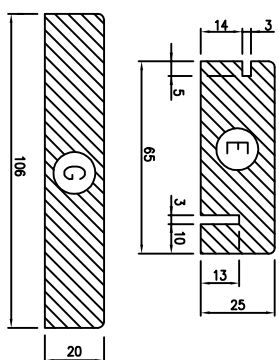

DIMENSIONI PANNELLO-ROZMĚRY PANELOU-ROZMĚRY PANELLU-TÜRMASSE-DOOR DIMENSIONS

SINCOLO-SAMOSTIŇIV-SAMOSTIŇIV-ENRFÜßSELIG-SINGLE		DOPPLIG-DVOUJITÝ-DVOUJITÝ-ZWEIFÜßSELIG-DOUBLE	
P x T	N	L x H	N
1200x2000	2	615 x 2010	4
1200x2100	2	615 x 2110	4
1400x2000	2	715 x 2010	4
1400x2100	2	715 x 2110	4
1600x2000	2	815 x 2010	4
1600x2100	2	815 x 2110	4
1800x2000	2	915 x 2010	4
1800x2100	2	915 x 2110	4
2000x2000	2	1015 x 2010	4
2000x2100	2	1015 x 2110	4
2200x2000	2	1115 x 2010	4
2200x2100	2	1115 x 2110	4
2400x2000	2	1215 x 2010	4
2400x2100	2	1215 x 2110	4

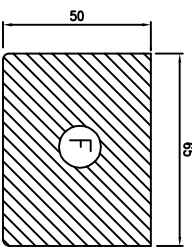
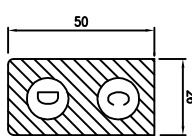
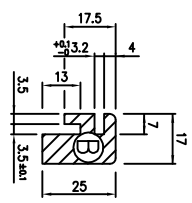
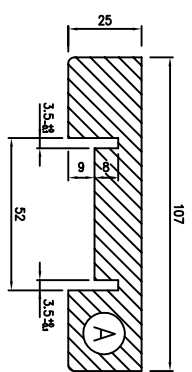
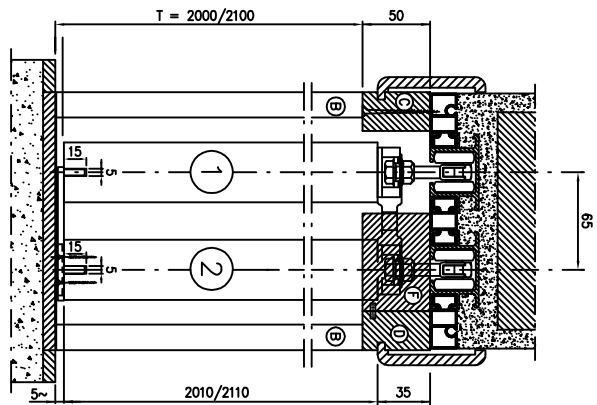
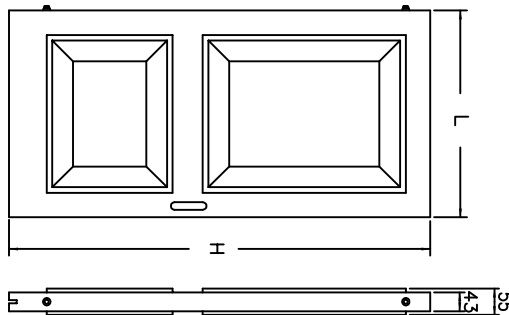

STIPITI-ZÁRUBNĚ-ZÁRUBNĚ-TÜRPFOSTEN-END POSTS

SEMPLICE-JEDNODUCHÁ-JEDNODUCHÁ-EINFACH-SINGLE		DOPPLIG-DVOUJITÝ-DVOUJITÝ-DOPPELT-DOUBLE	
P x T	A	B	C
1200x2000	1	2	1
1200x2100	1	2	1
1400x2000	1	2	1
1400x2100	1	2	1
1600x2000	1	2	1
1600x2100	1	2	1
1800x2000	1	2	1
1800x2100	1	2	1
2000x2000	1	2	1
2000x2100	1	2	1
2200x2000	1	2	1
2200x2100	1	2	1
2400x2000	1	2	1
2400x2100	1	2	1

